

SM23165D		
Continuous Torque	2.50	in-lb
	40	oz-in
	0.28	N-m
Peak Torque	4.00	in-lb
	64	oz-in
	0.45	N-m
Nominal Continuous Power	181	Watt
No Load Speed	10,400	RPM
Max. Continuous Current* @ 6500 RPM	4.70	Amps
Peak Power @ 6100 RPM	183	Watts
Voltage Constant	4.45	V/kRPM
Inductance	0.829	mH
Encoder Resolution	4,000	Counts/Rev
Rotor Inertia	0.00099	oz-in-sec ²
	0.6991	10 ⁻⁵ Kg-m ²
Weight	1.0	lb
	0.45	kg
Shaft Diameter	0.250	in
	6.35	mm
Shaft, Radial Load	7	lb
	3.18	kg
Shaft, Axial Thrust Load	3	lb
	1.36	kg
DeviceNet Available	Yes	
PROFIBUS Available	Yes	
CANopen Available	Yes	

*Default voltage is 48V. See graphs for additional voltages.

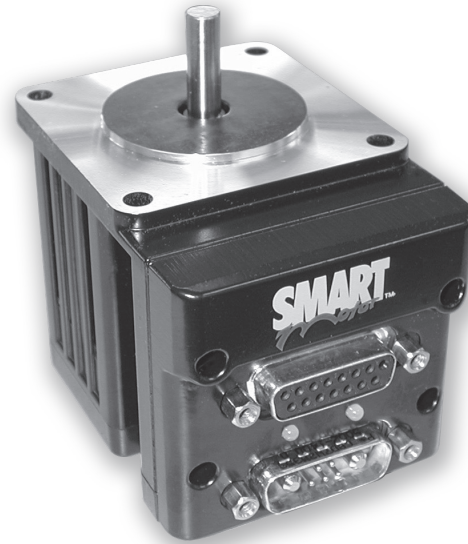

Operating temperature range: 0°C–85°C

Storage temperature range: -10°C–85°C, noncondensing

NOTE: Motor specifications are subject to changes without notice. Consult website and factory for latest data.



Moog Animatics SmartMotor™ SM23165D (No Options) CAD Drawing

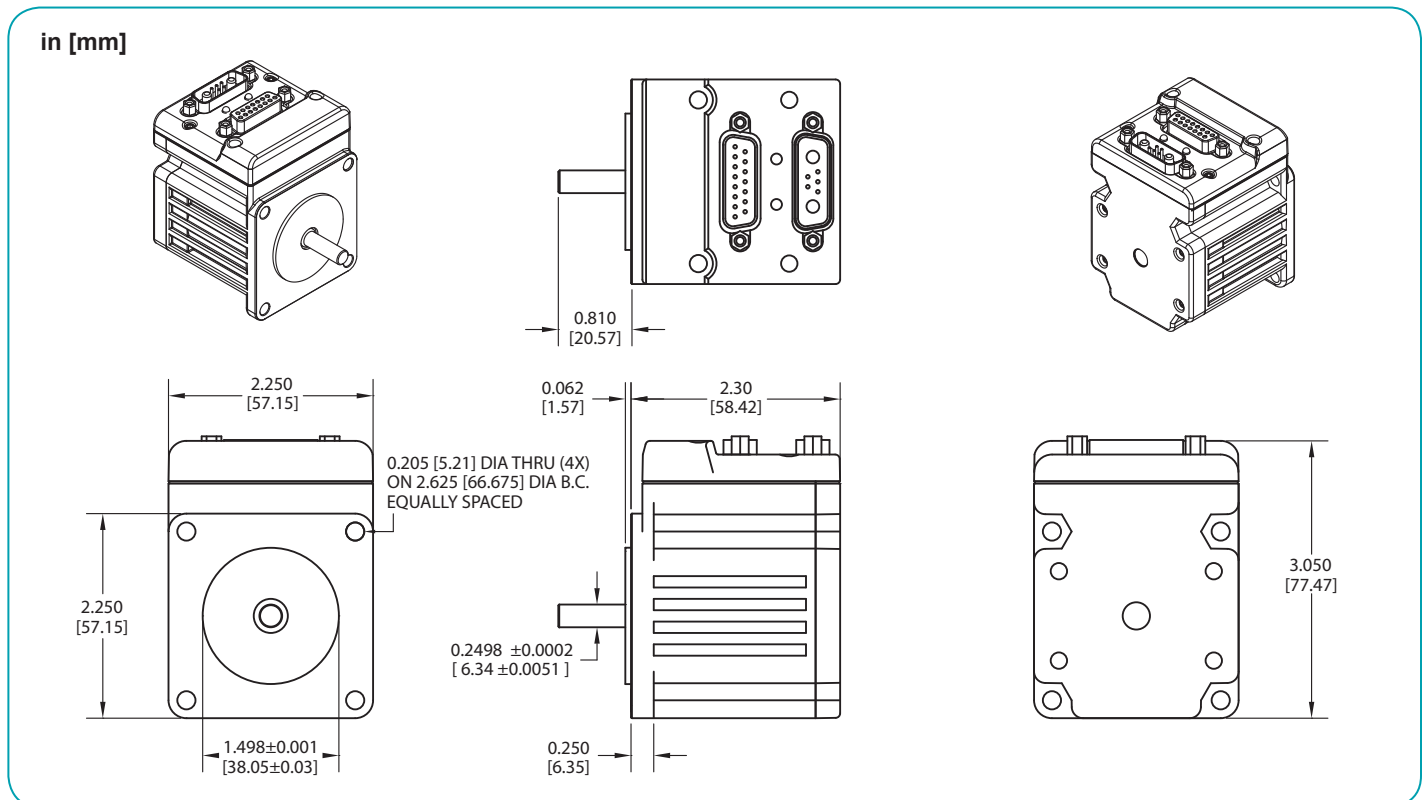

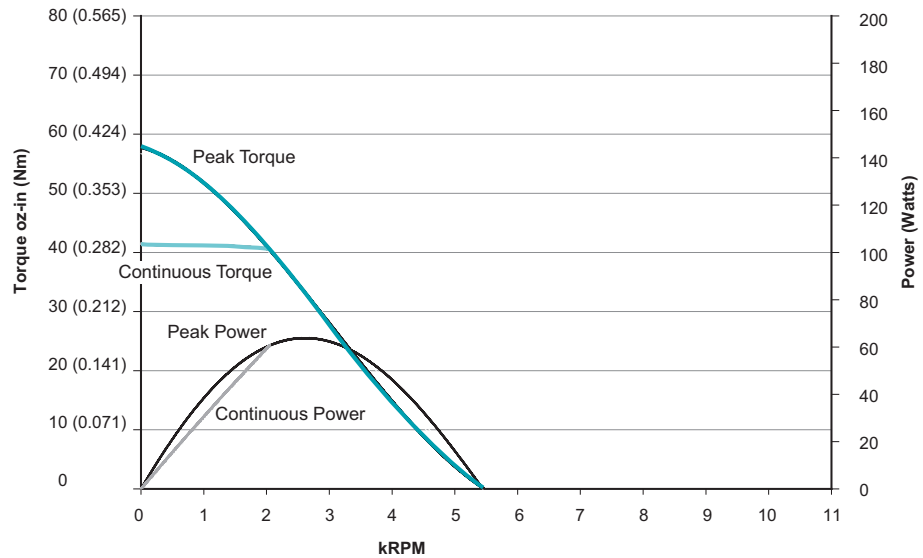
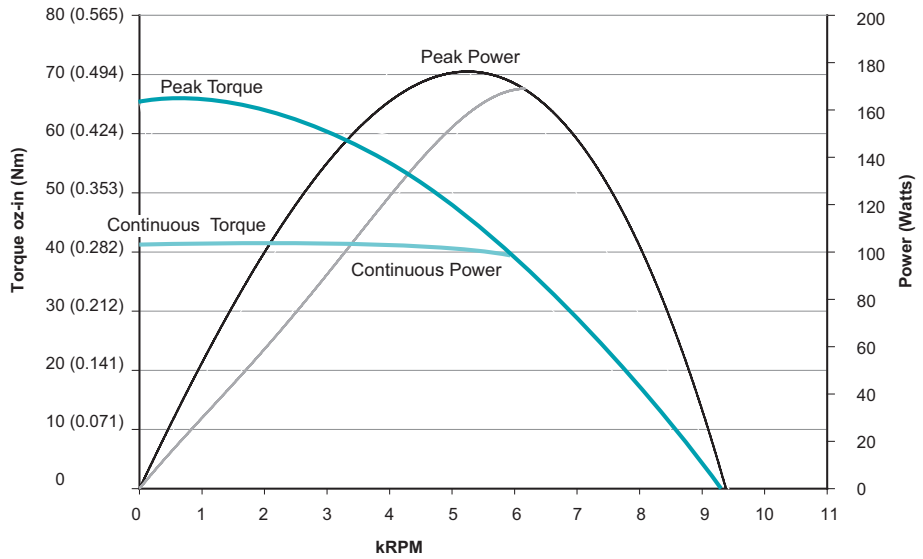
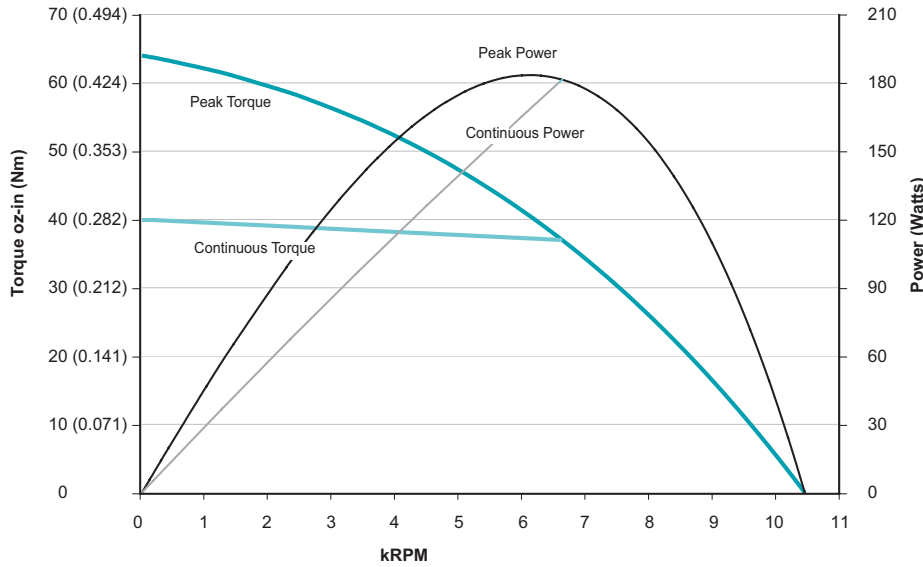

All torque curves based on 25°C ambient. Motors were operated using MDT (Trapezoidal Drive Mode) Commutation. For ambient temperatures above 25°C, Continuous Torque must be linearly derated to 0% at 85°C.

Class 5 D-Style Connector Pinouts

This table shows the pinouts for the connectors on the Class 5 D-style SmartMotors.

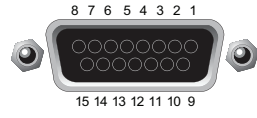
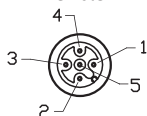
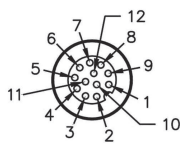
PIN	MAIN POWER	Specifications:	Notes:	P1
1	I/O - 6 GP, Index Input or "G" Command; For -CDS7, CAN-L only	25 mAmp Sink or Source 10 Bit 0-5 VDC A/D	Redundant connection on I/O connector	 <p>7W2 Combo D-Sub Connector</p>
2	+5 VDC Out; For -CDS7, CAN-H only	50 mAmps Max (total)		
3	RS-232 Transmit	Com ch. 0	115.2 KBaud Max	
4	RS-232 Receive			
5	Common Ground (typ. SIG Ground)			
A1	Main Power	+24-48 VDC	See NOTE	
A2	Common Ground (req'd. POWER Ground)		Must be Main Power Ground	
PIN	I/O CONNECTOR (5V TTL I/O)	Specifications:	Notes:	P2
1	I/O - 0 GP or Encoder A or Step Input		1.5 MHz Max as Encoder or Step Input	 <p>P2 DB-15 D-Sub Connector</p>
2	I/O - 1 GP or Encoder B or Direction Input		1.5 MHz Max as Encoder or Direction Input	
3	I/O - 2 Positive Over Travel or GP			
4	I/O - 3 Negative Over Travel or GP	25 mAmp Sink or Source 10 Bit 0-5 VDC A/D		
5	I/O - 4 GP, IIC (SDA) or RS-485 A (Com ch. 1)		115.2 KBaud Max	
6	I/O - 5 GP, IIC (SCL) or RS-485 B (Com ch.1)			
7	I/O - 6 GP, Index Input or "G" Command		Redundant connection on Main Power Connector	
8	Phase A Encoder Output	24 mAmp Sink or Source		
9	Phase B Encoder Output			
10	RS-232 Transmit; For -CDS/7, CAN-L only	Com ch. 0	115.2 KBaud Max	
11	RS-232 Receive; For -CDS/7, CAN-H only			
12	+5 VDC Out	50 mAmp Max (total)		
13	Common Ground (typ. SIG Ground)			
14	Common Ground			
15	Main Power: +20-48 VDC	If DE Option, Control Power separate from Main Power		
NOTE: I/O ports input impedance = 5 kohm (5 kohm pull-up resistor)				
PIN	CAN bus	Connection:	Notes:	P3
1	NC	NC		 <p>M12 5-Pin Female</p>
2	+V	NC except DeviceNet	Input current < 10 mA	
3	-V (ground, not common)	CAN Ground	Isolated	
4	CAN-H	1 MBaud Max		
5	CAN-L	1 MBaud Max		
PIN	Isolated 24 VDC I/O Connector	Max Load (sourcing)	Notes:	P4
1	I/O - 16 GP		These I/O ports also support analog input	 <p>M12 12-Pin Female End View</p>
2	I/O - 17 GP	150 mAmps		
3	I/O - 18 GP			
4	I/O - 19 GP			
5	I/O - 20 GP			
6	I/O - 21 GP			
7	I/O - 22 GP	300 mAmps		
8	I/O - 23 GP			
9	I/O - 24 GP			
10	I/O - 25 GP			
11	+24 Volts Input	18-32 VDC		
12	Ground-I/O (not common)		Isolated	

NOTE: These motors can operate on power down to +20 VDC, but it is not recommended due to greatly reduced performance — optimum performance is achieved at 48 VDC.

NOTE: All specifications are subject to change without notice. Consult the factory for the latest information.

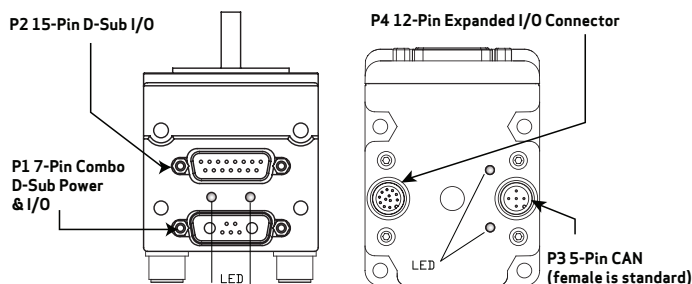

CAUTION: Pins 14 and 15 are intended for use with DE series motors for control power only. Attempting to power a non-DE motor through those pins, as main servo-drive power, may result in immediate damage to the electronics, which will void the warranty.

CAUTION: Connectors P3 and P4 must be finger tightened only! DO NOT use a tool. Doing so can cause overtightening of the connection, which may damage the connector and will void the warranty.